

HAR

Space-saving Fittings

Plug-in fittings allow a quick connection of the system by optimizing the space and they facilitate maintenance and replacement of installations.



TECHNICAL CHARACTERISTICS

Temperature	0 ÷ 60 °C
Fluid	compressed air, vacuum
Working pressure	-0,99 ÷ 10 bar
Application fields	pneumatic circuits
Recommended hoses	polyamide PA 10.12, polyurethane Sh.A98 co-polyurethane Sh.55D

CONSTRUCTIVE CHARACTERISTICS

Body	technopolymer
Fixing elements	nickel-plated brass with O-ring in NBR
Clamp	stainless steel
Release ring	technopolymer

HAR04 T Miniature straight male

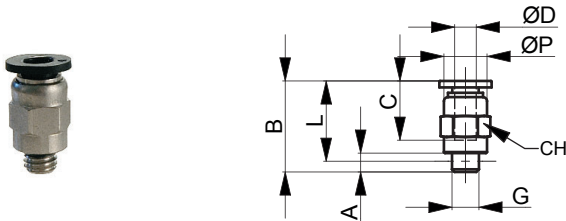

Part No.	ØD	G	A	B	L	ØP	C	CH
HAR0403M3	3	M3x0.5	3.0	14.6	13.5	5.5	10.6	5.5
HAR0404M3	4	M3x0.5	3.0	16.4	15.6	8.0	11	8.0
HAR0404M5	4	M5x0.8	3.5	16.9	15.6	8.0	11	8.0

HAR10B Miniature swivel elbow male

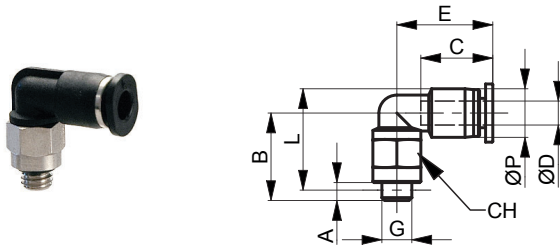

Part No.	ØD	G	A	B	L	ØP	C	E	CH
HAR10B03M3	3	M3x0.5	3.0	12.7	14.3	6.2	9.3	11.1	5.5
HAR10B04M3	4	M3x0.5	3.0	13.6	16.6	8.1	12	16	8.0
HAR10B04M5	4	M5x0.8	3.5	15.6	17.4	8.1	12	16	8.0

HAR12B Miniature extended swivel elbow male

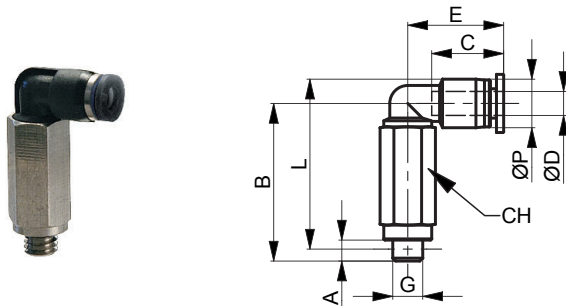

Part No.	ØD	G	A	B	L	ØP	C	E	CH
HAR12B03M3	3	M3x0.5	3.0	12.8	14.7	6.2	9.3	11.4	5.5
HAR12B04M3	4	M3x0.5	3.0	15.3	17.8	8.1	12	14.7	8.0
HAR12B04M5	4	M5x0.8	3.5	15.8	18.3	8.1	12	14.7	8.0

HAR14B Miniature low lateral Tee male

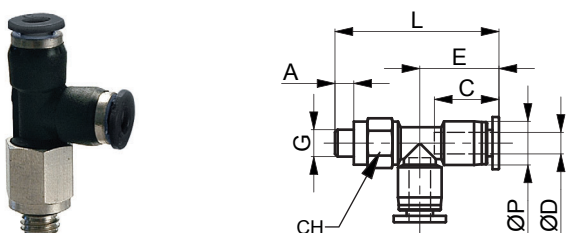

Part No.	ØD	G	A	ØP	E	C	L	CH
HAR14B03M3	3	M3x0.5	3.0	6.2	11.4	9.3	24.1	5.5
HAR14B04M3	4	M3x0.5	3.0	8.1	14.7	12	31	8
HAR14B04M5	4	M5x0.8	3.5	8.1	14.7	12	31.5	8

5

HAR16B Miniature low central Tee male

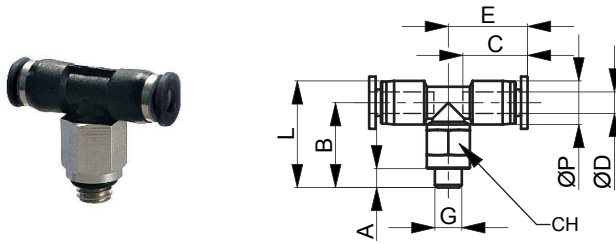

Part No.	ØD	G	A	ØP	E	C	L	B	CH
HAR16B03M3	3	M3x0.5	3.0	6.2	11.4	9.3	14.7	12.8	5.5
HAR16B04M3	4	M3x0.5	3.0	8.1	14.7	12	17.8	15.3	8.0
HAR16B04M5	4	M5x0.8	3.5	8.1	14.7	12	18.3	15.8	8.0

HAR19 Miniature intermediate straight

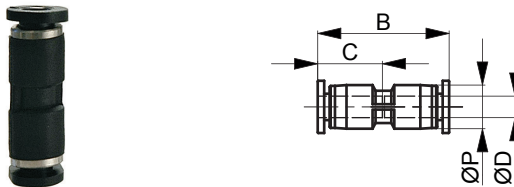

Part No.	ØD	B	ØP	C
HAR190300	3	19.8	6.2	9.3
HAR190400	4	25.2	8.1	12

HAR20 Miniature intermediate elbow

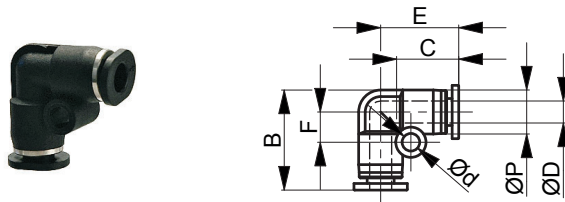

Part No.	ØD	B	ØP	C	E	Ød	F
HAR200300	3	14.5	6.2	9.3	11.4	3.2	4.7
HAR200400	4	18.3	8.1	12	14.2	3.2	6.0

5

HAR21 Miniature intermediate Tee

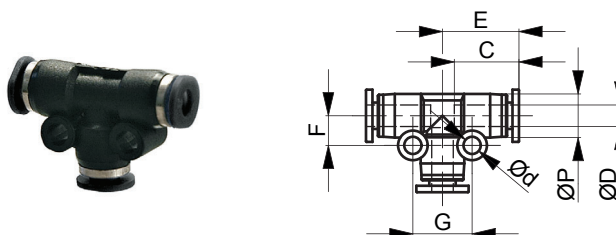

Part No.	ØD	ØP	C	E	Ød	F	G
HAR210300	3	6.2	9.3	11.4	3.2	4.2	11
HAR210400	4	8.1	12	14.2	3.2	6.0	11

HAR23 Miniature intermediate Y

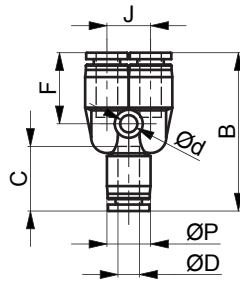

Part No.	ØD	Ød	B	ØP	C	J	F
HAR230300	3	3.2	28.8	8.1	9.3	8.1	12.9
HAR230400	4	3.2	29.4	8.1	12	8.1	13.2