

# AUTOMOTIVE DIVISION



A **single supplier**  
with **a complete**

**Pneumatic Components**  
for **Automation**

**Clamping**

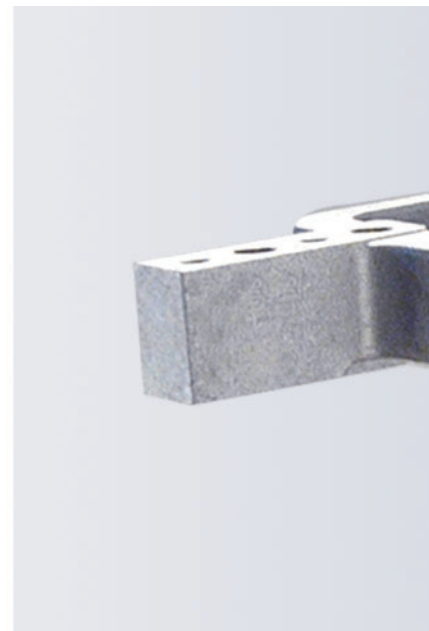

# product range for

**Technology**

**GR8**  
Modular Tooling System

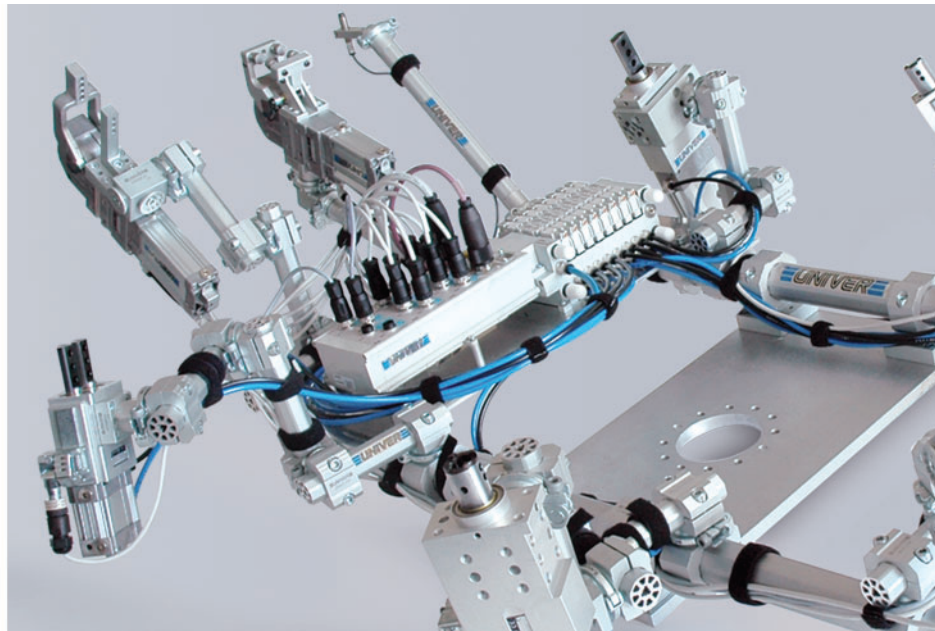
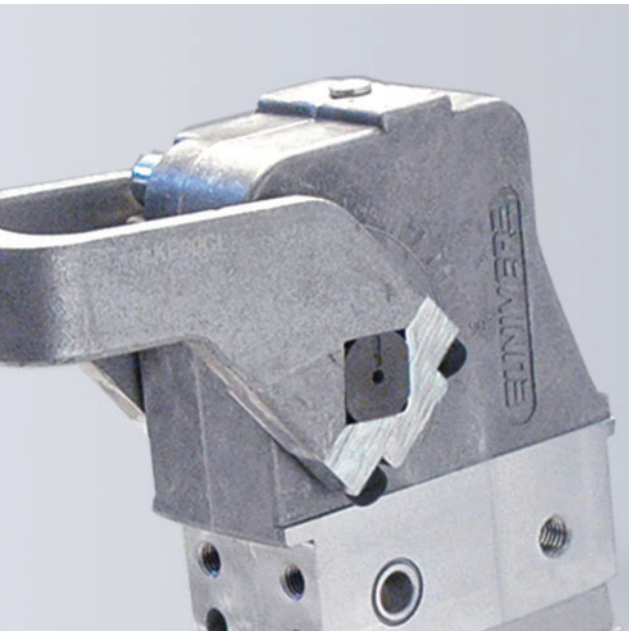





# Our customers

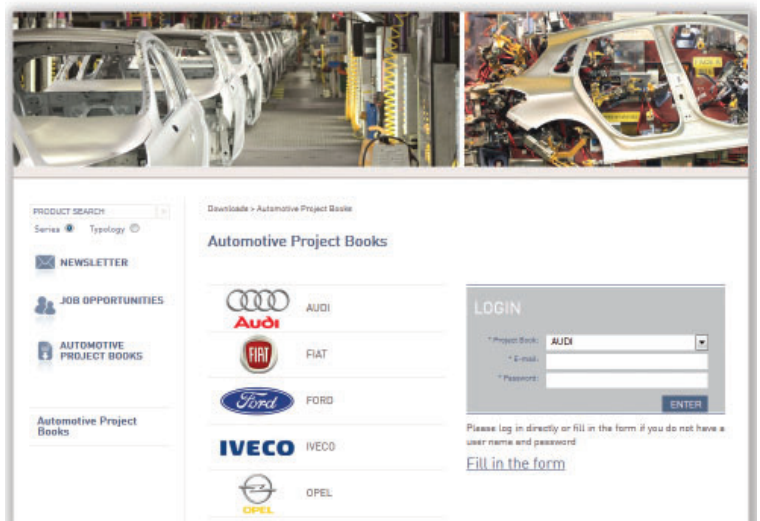
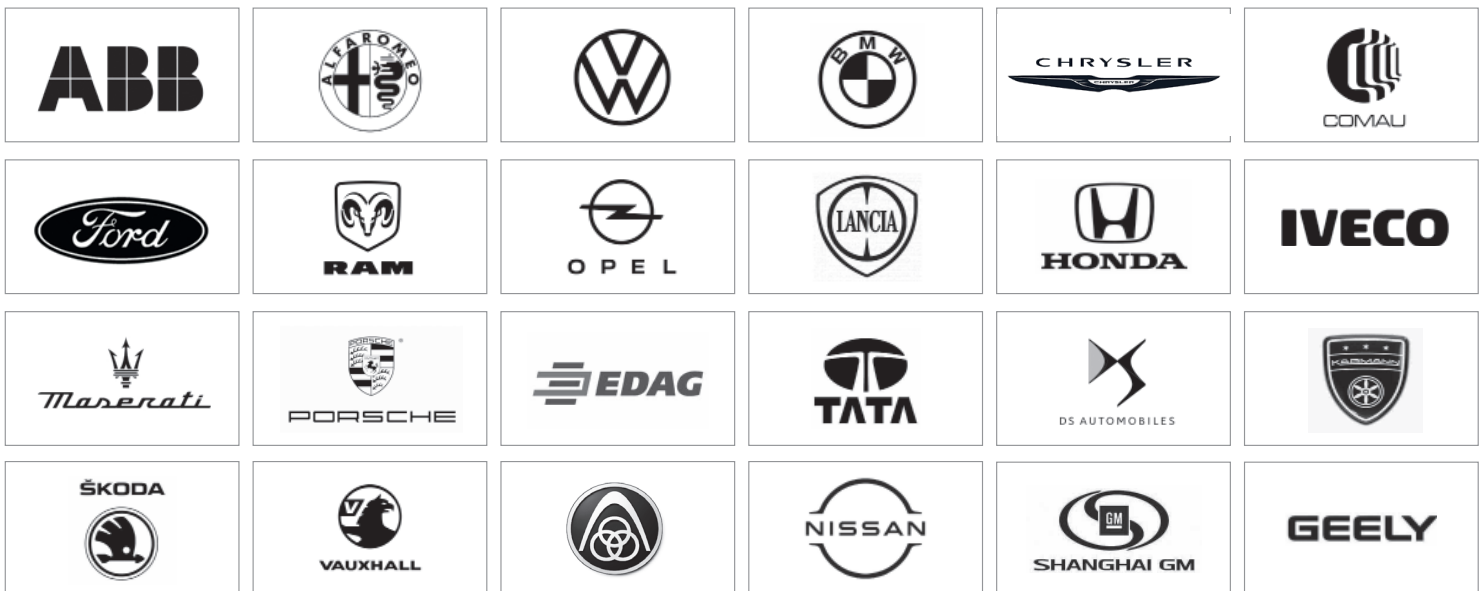



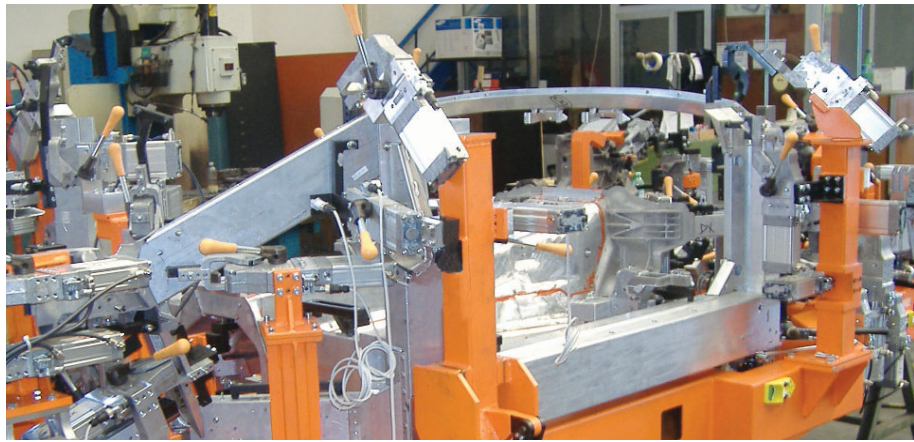





Online Project Books  
[www.univer-group.com](http://www.univer-group.com)



# Complete range

## Clamping Technology

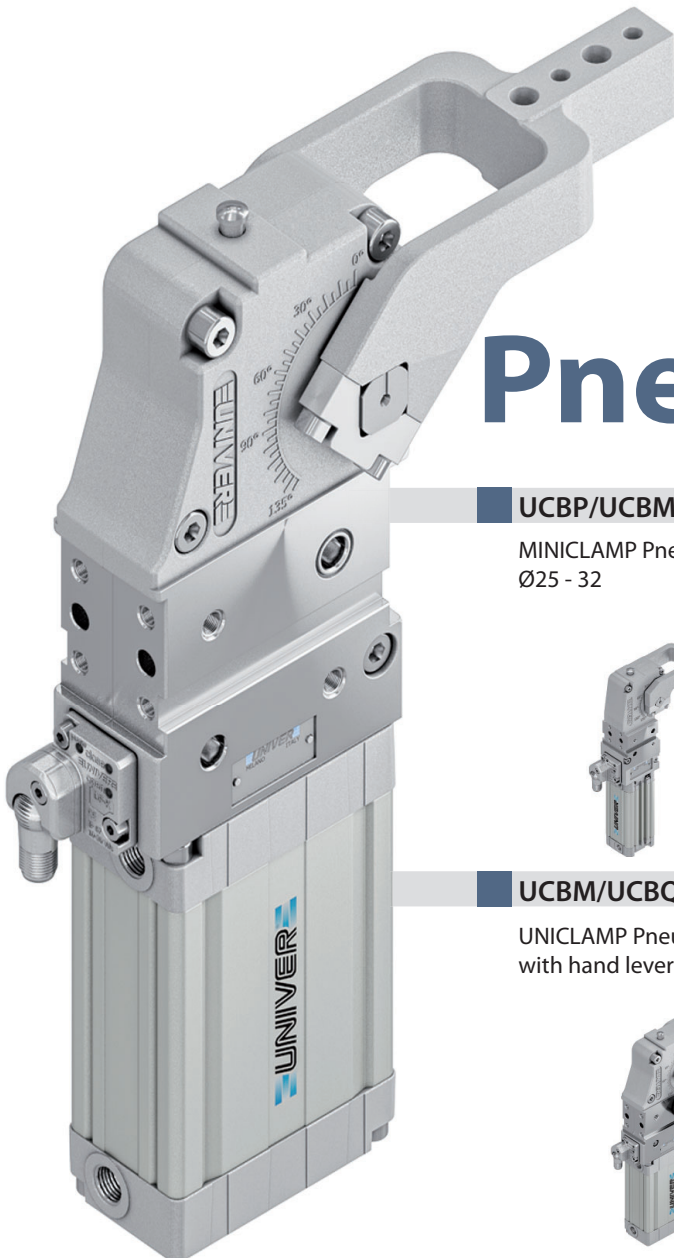
**ATEX**   
Certified products  
Available on request



# Pneumatic Power

### UCBP/UCBM

MINICLAMP Pneumatic Power Clamps  
Ø25 - 32

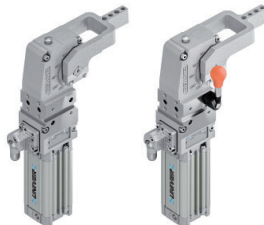

### UCBP/UCBH

UNICLAMP Pneumatic power clamps  
Ø40 - 50 - 63 - 80



### UCBM/UCBQ

UNICLAMP Pneumatic power clamps  
with hand lever Ø40 - 50 - 63 - 80



### UCIM

UNICLAMP Pneumatic power clamps Ø40 with  
hand lever interchangeable with size 50/63 mm



# Clamps conforming to the **NAAMS** standard

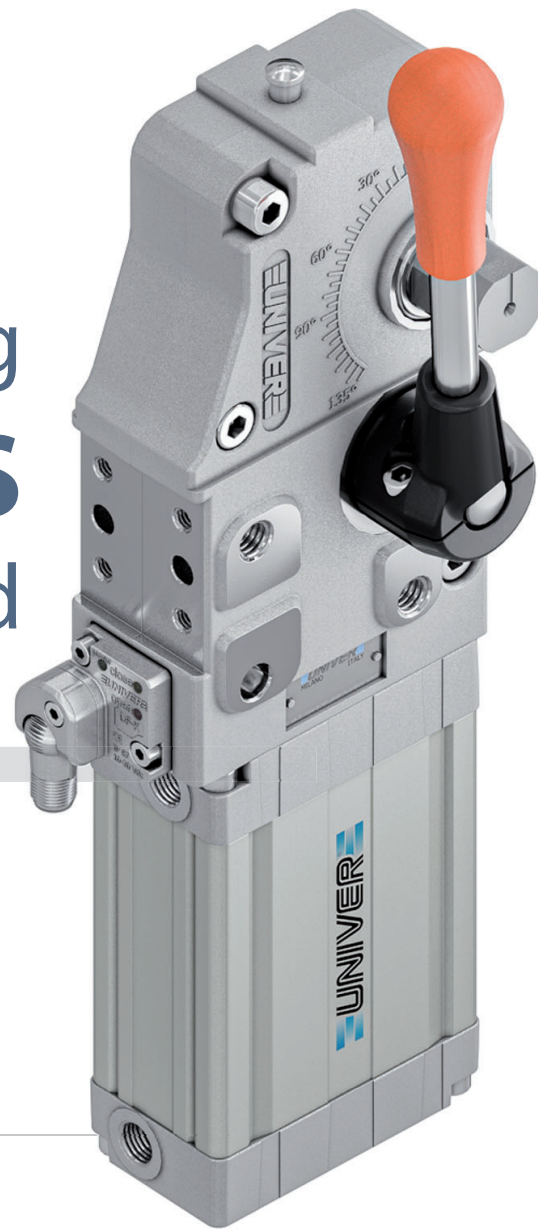

## UCNP

UNICLAMP Pneumatic power clamps conforming to the N.A.A.M.S. Standard Ø50 - 63 - 80



## UCNM

UNICLAMP Pneumatic power clamps with hand lever conforming to the N.A.A.M.S. Standard Ø50 - 63 - 80



# Clamps

## UCIP

UNICLAMP Pneumatic power clamps Ø40 interchangeable with size 50/63 mm



## UCDP

UNICLAMP Pneumatic power clamps with 2 arms Ø40 - 63



## UA

BLUECLAMP Pneumatic power clamps Ø32 - 40 - 50 - 63 - 80 - Air saving

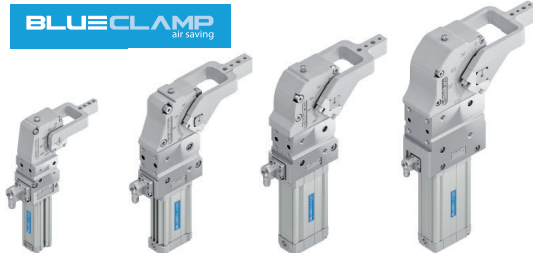

## UCBT

UNICLAMP Pneumatic power clamp Ø40 with central hand lever



## UCBL

UNICLAMP Manual power clamps size 50-63







# Complete range

## Pin Packages

**ATEX**   
Certified products  
Available on request

### ULM

UNICLAMP Pneumatic retractable locating pin unit with single rod and hand lever Ø50



### ULY

UNICLAMP Pneumatic retractable locating pin unit with single rod, hand lever and toggle-joint mechanism Ø40



# Retractable locating single and double rod

### ULP

UNICLAMP Pneumatic retractable locating pin units with single rod Ø32 - 50 - 63



### LCG

Pneumatic retractable locating pin units with single rod, conforming to the CNOMO standard Ø50 - 63



### ULB

UNICLAMP Pneumatic retractable locating pin units with double guide and rear sensor Ø32



# Pneumatic retractable locating pin units with handlever



## ULO

UNICLAMP Pneumatic retractable locating pin unit with orientable double rod and hand lever Ø50



## ULX

UNICLAMP Pneumatic retractable locating pin unit with orientable double rod, hand lever and toggle-joint mechanism Ø50

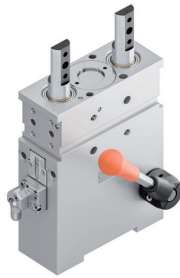

## ULL

UNICLAMP Manual retractable locating pin unit with single rod size 50



# pin units

## ULZ

UNICLAMP Pneumatic retractable locating pin units with single rod and toggle-joint mechanism Ø40



## ULA

UNICLAMP Pneumatic retractable locating pin units with orientable double rod Ø40 - 63



## ULT

UNICLAMP Pneumatic retractable locating pin units with orientable double rod and toggle-joint mechanism Ø50

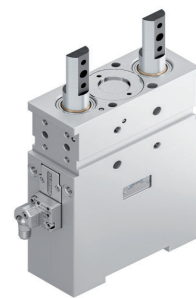



# Complete range

## Pin Clamps

**ATEX**   
Certified products  
Available on request

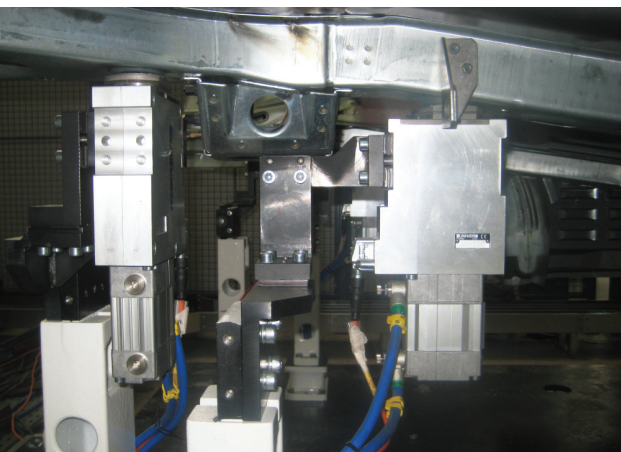

# Pneumatic pin clamps

**USP/USS**

UNICLAMP Pneumatic pin clamps



**USC/USR**

UNICLAMP Compact pin clamps



**USP50U**

UNICLAMP Pneumatic pin clamps horizontal shape

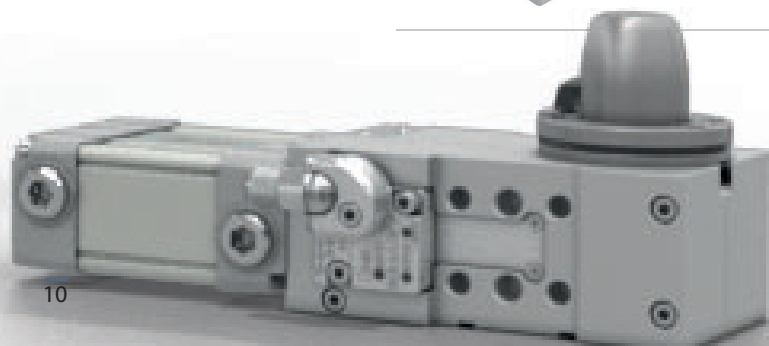



# Gripper Units



## UGP

UNICLAMP Pneumatic gripper units Ø40



## UGM

UNICLAMP Pneumatic gripper units with hand lever Ø40



## UGPS

UNICLAMP Pneumatic grippers Ø32 - 40



## USSL

UNICLAMP Pneumatic pin clamps for laser beam applications



## UST

UNICLAMP Pneumatic pin clamps with vanishing hook



## LUP

Pneumatic pin clamps with vanishing hook and pin



## USL

Manual pin clamps





# Complete range

Pivot Units

**ATEX**   
Certified products  
Available on request

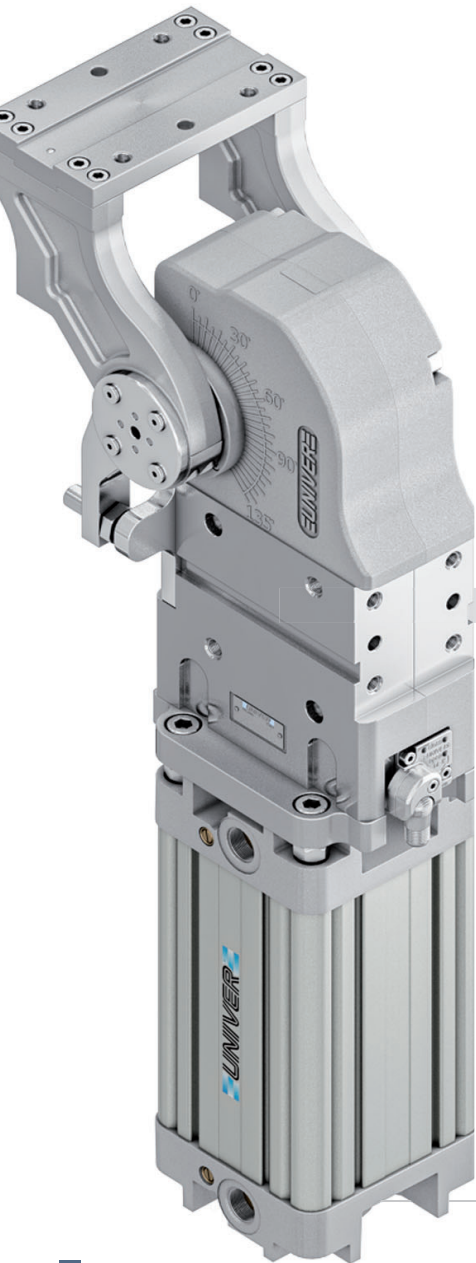

# Power Pivots

**UAGP\_B**

Power pivots - **WITH BRAKE**



110 Nm

**SMALL SIZE**

(60 - 110 - 170 Nm)



120 Nm

**MEDIUM SIZE**

(75 - 120 - 300 Nm)



350 Nm

**LARGE SIZE**

(210 - 350 - 600 Nm)



# Marking Units

## UPR

UNICLAMP Marking unit with marking head 5000 Nm/12000 Nm

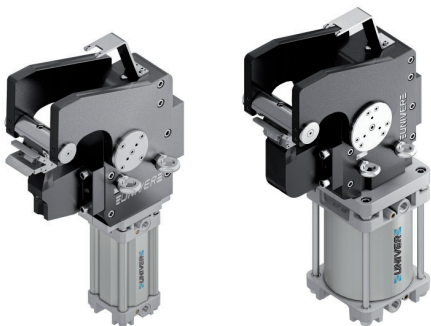

## UPD

UNICLAMP Marking unit 1 character 250 Nm/500 Nm

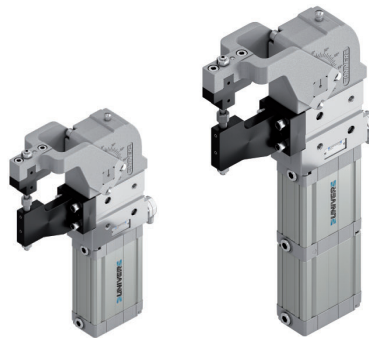

## UAGP\_W

Power pivots - **WITHOUT BRAKE**



110 Nm

### SMALL SIZE

(60 - 110 - 170 Nm)



120 Nm

### MEDIUM SIZE

(75 - 120 - 300 Nm)



350 Nm

### LARGE SIZE

(210 - 350 - 600 Nm)





# Complete range

## Electric Units

**ATEX**   
Certified products  
Available on request



## Electric units

**LAE**

Electric power clamps

**LNE**

Electric power clamps, fixing  
conforming to the N.A.A.M.S.  
Standard

**LGE**

Electric gripper units



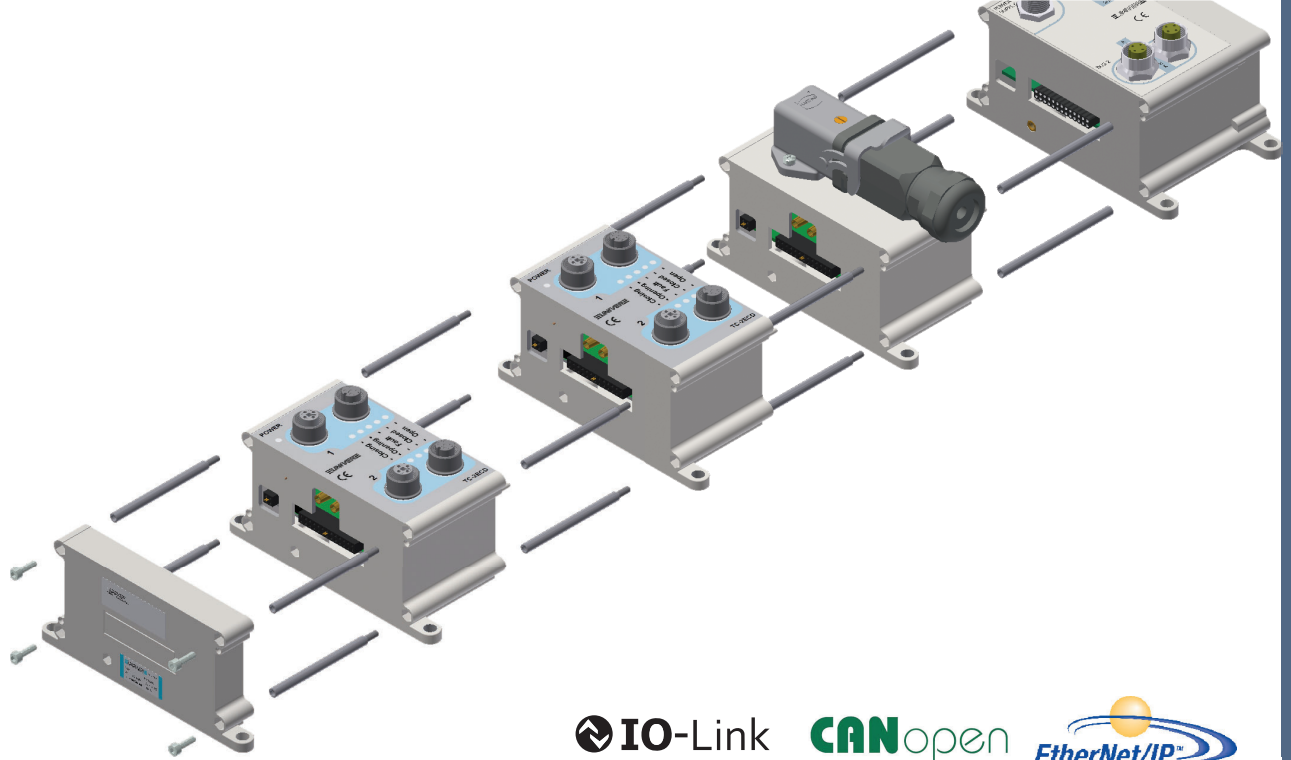

**IO-Link**

**CANopen**

**EtherNet/IP™**

**PROFI<sup>®</sup>  
BUS**

**PROFI<sup>®</sup>  
NET**

**EtherCAT<sup>®</sup>**

# TC-E

## Modular Control System for Electric Clamping Units



**SERIAL  
COMMUNICATION  
SYSTEM**

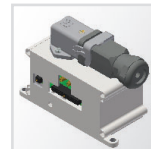

**POWER UNIT**  
EFFICIENT power management



**ELECTRIC UNIT DRIVER**  
Control module for 2 clamping units  
Max 8 electric devices



**FLEXIBLE**  
Compatible with I/O modules  
and valve manifolds

### LCE

Electric retractable locating  
pin units



### UAEP

ePIVOT Electric Power Pivot



### CUSTOMER ORIENTED DESIGN

**100% UNIVER**  
Plug-n-Play



**CUSTOMER-SELECTED  
MOTOR**

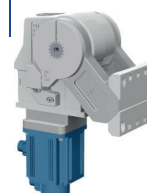

**MOTORLESS**

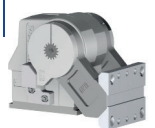

**ePIVOT**  
electric power



# Complete range

Pneumatic Automation for Automotive

**ATEX**   
Certified products  
Available on request

K	KD	RM	JLES/JLEV
ISO 15552 Pneumatic Cylinders	Ø 32 ÷ 125 mm ISO 15552 Pneumatic Cylinders HEAVY SERIES TUBE	Ø 16 ÷ 100 mm - ISO 21287 Compact Cylinders	Guided Compact Cylinders Bearings (JLES) Ball bushing (JLEV)



# Valves

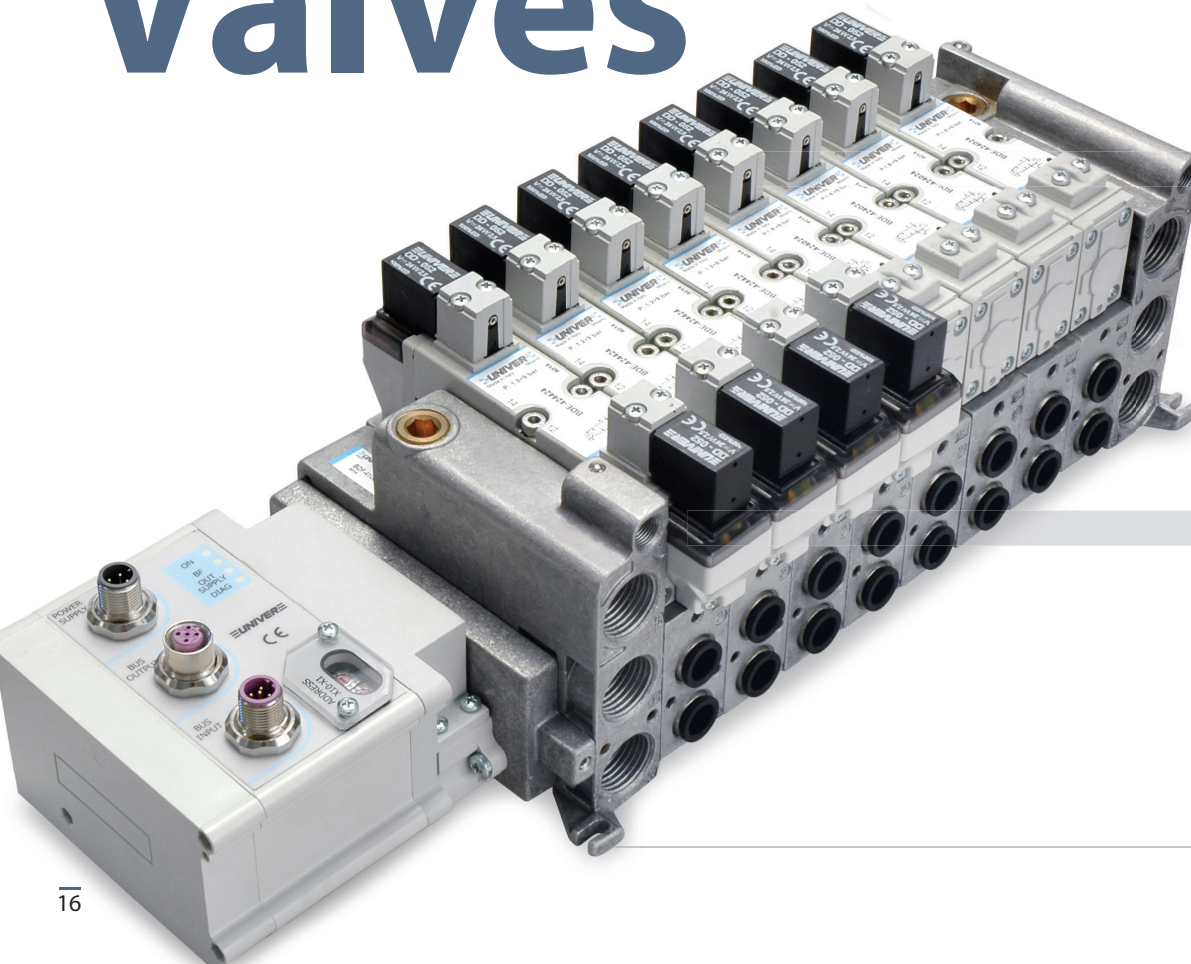

**BE**  
ISO 5599/1 Valves size 1-2-3-4

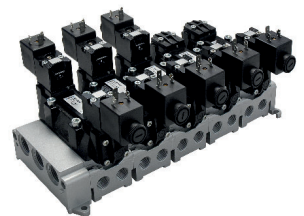

**AC**  
Mixed Valves G1/8-G1/4-G1/2





# Cylinders

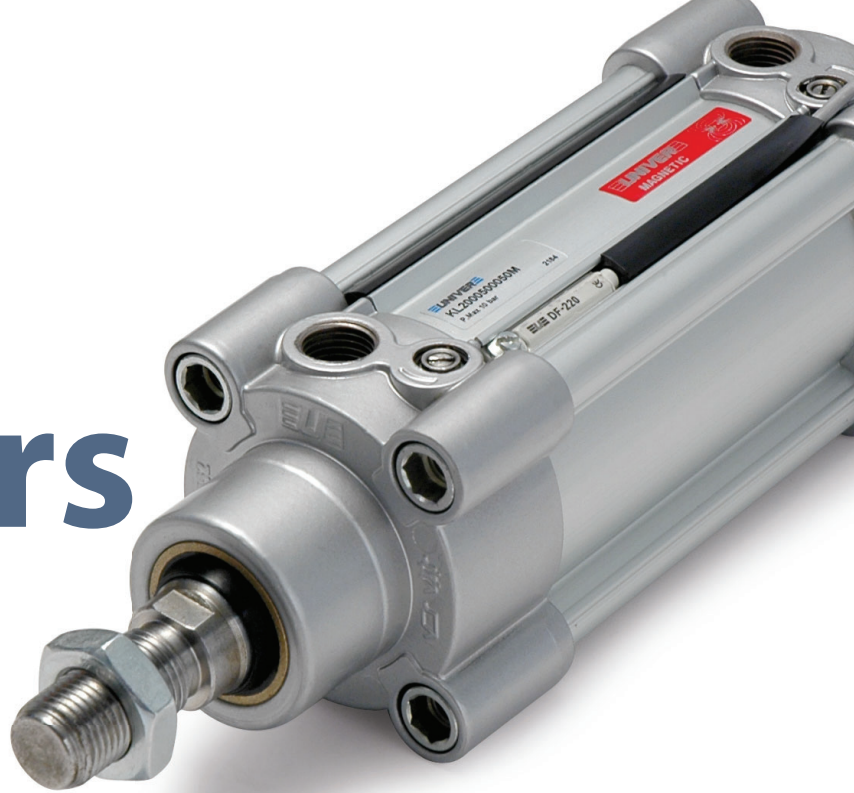

**R**

Ø 32 ÷ 125 mm  
Pneumatic Rotary Actuators

**S1**

Ø 16 ÷ 50 mm  
Rodless Cylinders  
Standard version

**J**

Slide Units  
for pneumatic cylinders

**RT**

Ø 25 ÷ 63 mm  
2/3 stage  
Telescopic Pneumatic Cylinders

**L1-N**

Locking unit for  
cylinders and piston rods

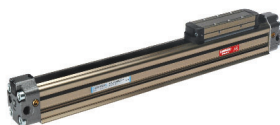

**BE12**

ISO 5599/1 Valves size 1-2-3-4



**BD 18 mm**

ISO 15407 -1/2 Valves

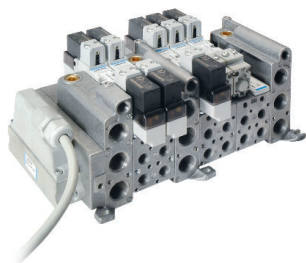

**BD 26 mm**

ISO 15407 -1/2 Valves



**AG**

Poppet Valves for vacuum  
G1/8 ÷ G1 1/2



**P15**

15 mm COMPACT Valves

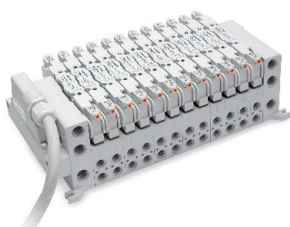

**TC**

Serial Communication Systems

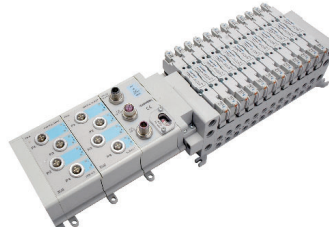

 **IO-Link**

 **CANopen**

 **PROFINET**

 **PROFIBUS**

 **DeviceNet**

 **EtherCAT**

 **EtherNet/IP**



# Complete range

Pneumatic Automation for Automotive

# Air Treatment

<b>HZE-Y</b> Gradual starter	<b>HZE-N</b> Diverter block	<b>HZE-P</b> Lockable valve	<b>HZE-S</b> Shut-off valve	<b>HZE-RL</b> Lockable regulator	<b>HZRE3</b> Electropneumatic proportional regulators G1/8 - G1/4 - G1/2
---------------------------------	--------------------------------	--------------------------------	--------------------------------	-------------------------------------	---



<b>HB</b> Nickel-plated Brass Push-in Fittings	<b>HA</b> Technopolymer Push-in Fittings
---	---



# HZE

Size 0 - 05 - 1 - 2

G1/4 ÷ G1/2

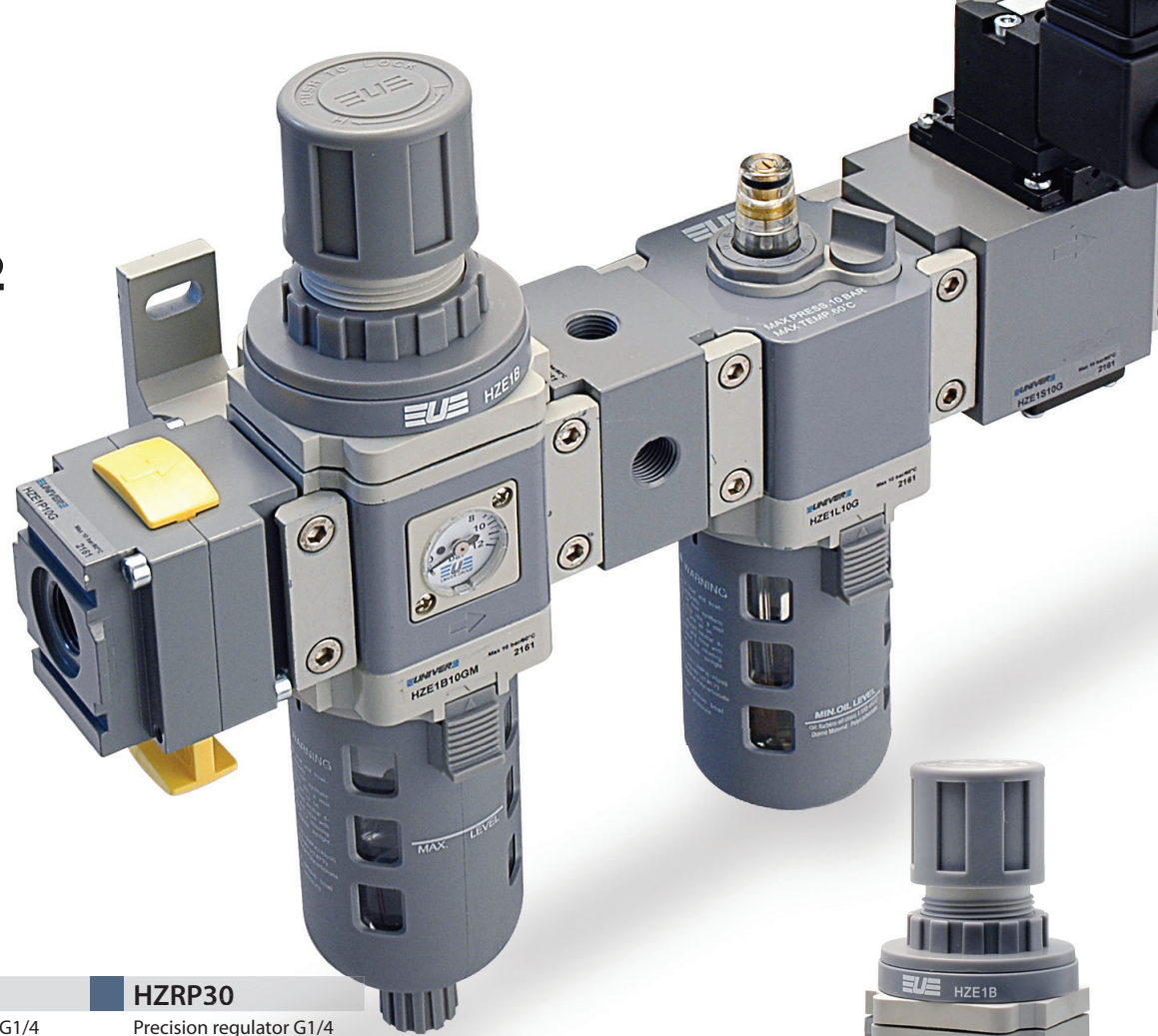

## HZRS

Mini regulator G1/4

## HZRP30

Precision regulator G1/4



# Accessories

## HGU

Quick Couplings for Compressed Air



## HC

Fittings and Accessories with pneumatic functions



## AM-55

Blocking valve



## AM-53

Economizer G1/8 ÷ G1

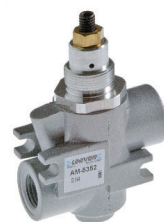





# GR8

Modular Tooling System

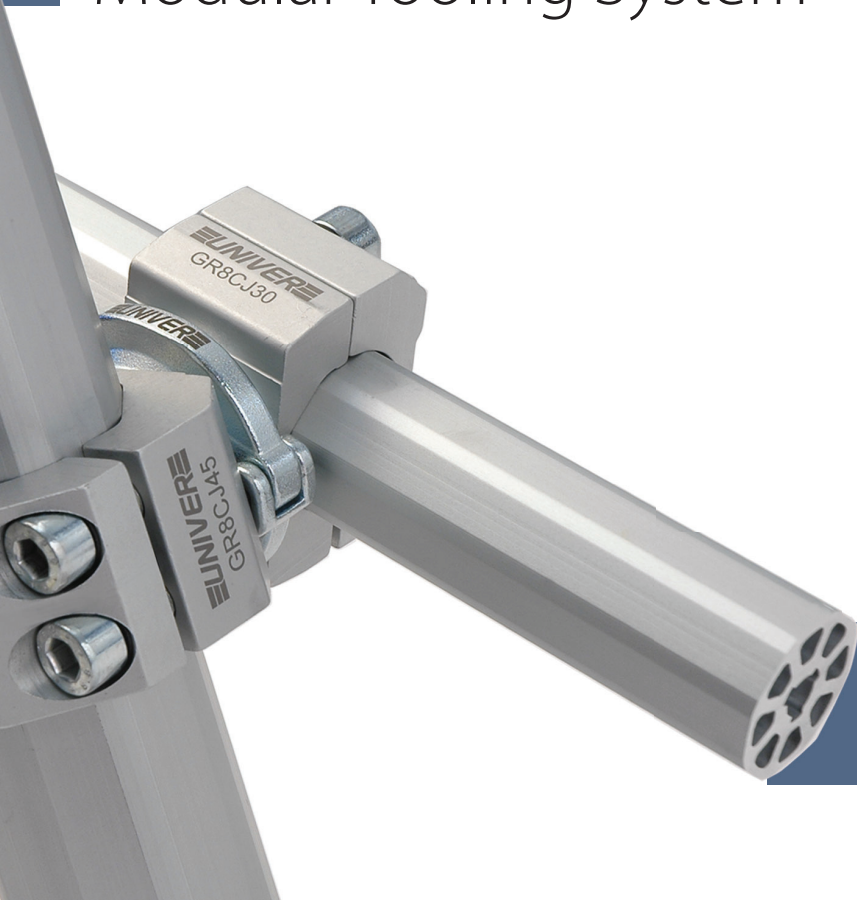

## KIT

Considerable **reduction**

Ø 30 - 45 - 70 mm booms

Maximum stiffness and minimum weight



**UNIVER**  
Original

30



45



70

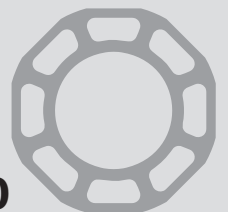



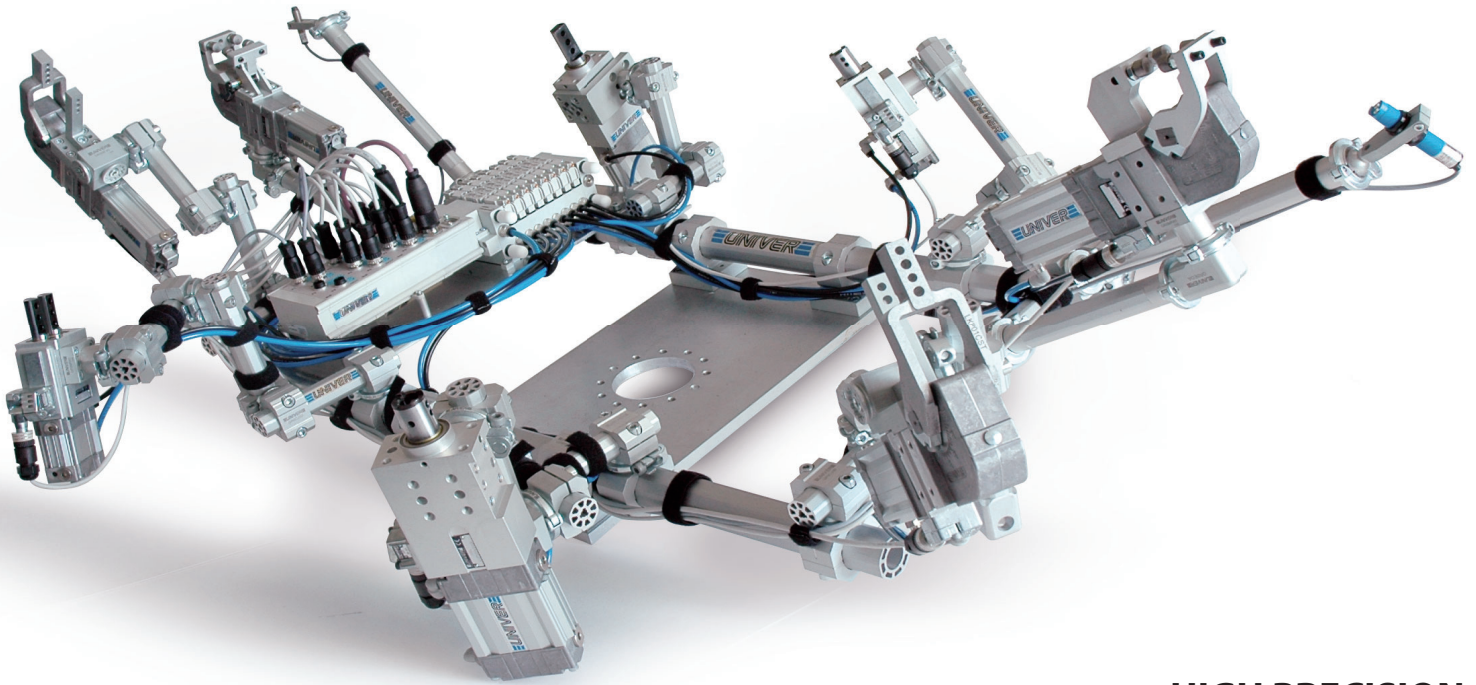

# of mounting elements

## HIGH PRECISION

High level of positional repeatability; low deflection

## MODULAR COMPONENTS

Considerable reduction of mounting components

## QUICK INSTALLATION AND SET UP

No welding or doweling required,  
easily replaceable components

## FULLY ADJUSTABLE

Unlimited orientation in space and free configuration

### Locking ring

Precise and efficient system to guarantee a high level of positional accuracy

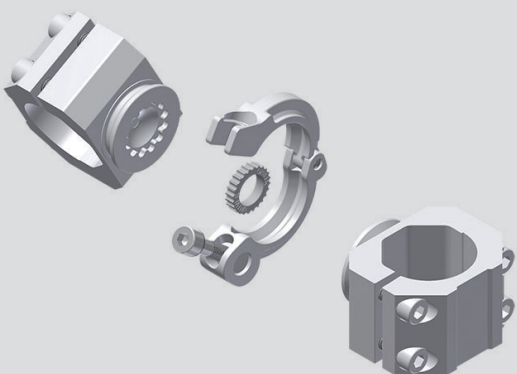

### Ball mounting

Unlimited swivel rotation

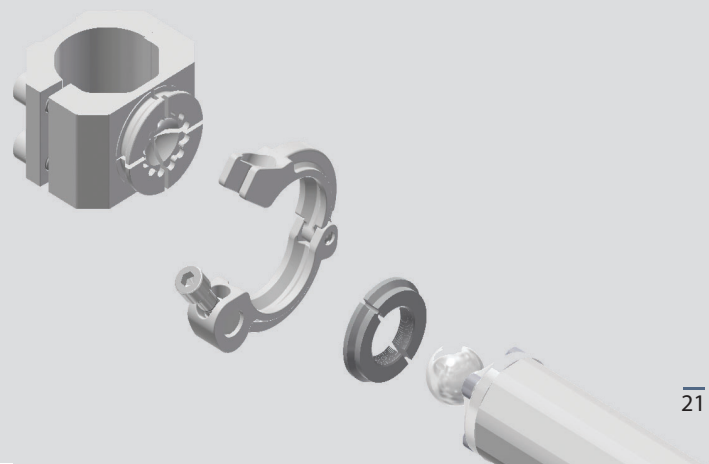



# GR8

## End Effectors

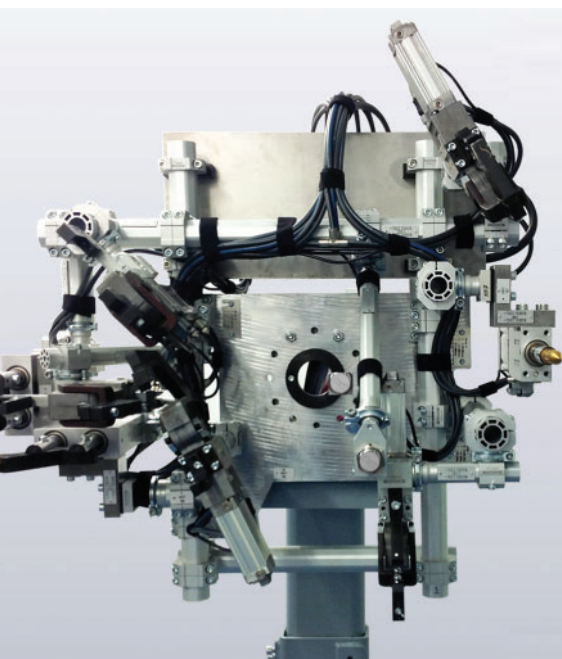
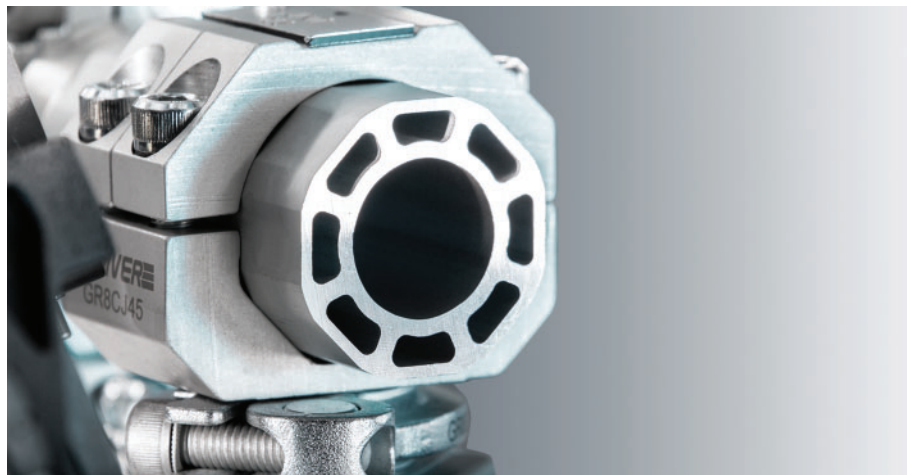

Applications and details

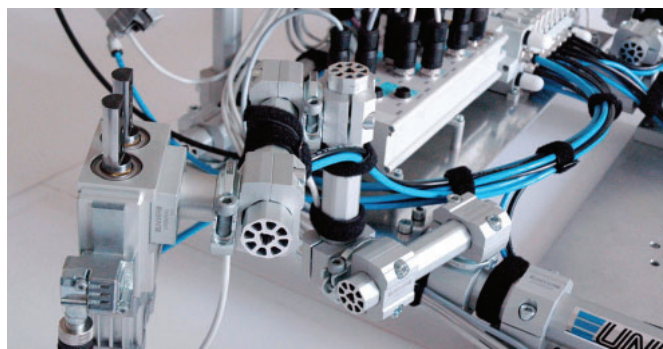

- Unlimited and complex configurations
- Weight-optimized standard components and brackets
- Quick installation and adjustment



# Complete Solution with UNIVER Components

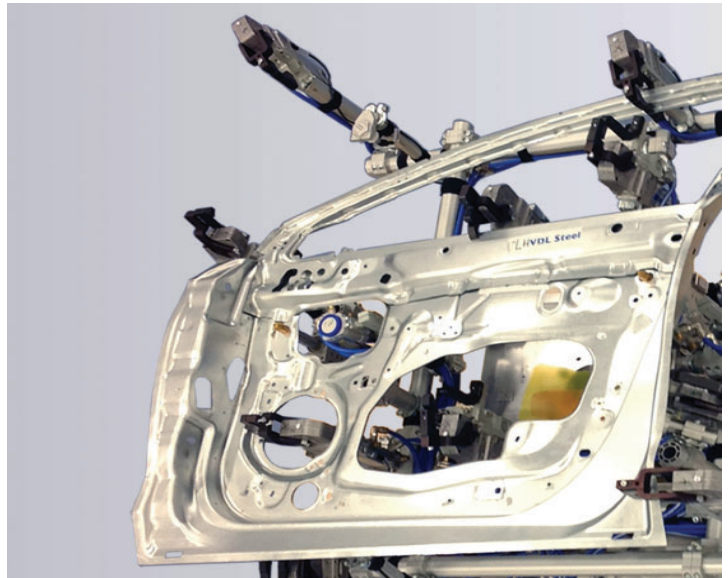
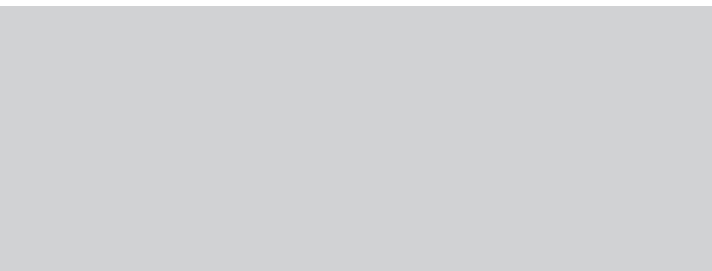
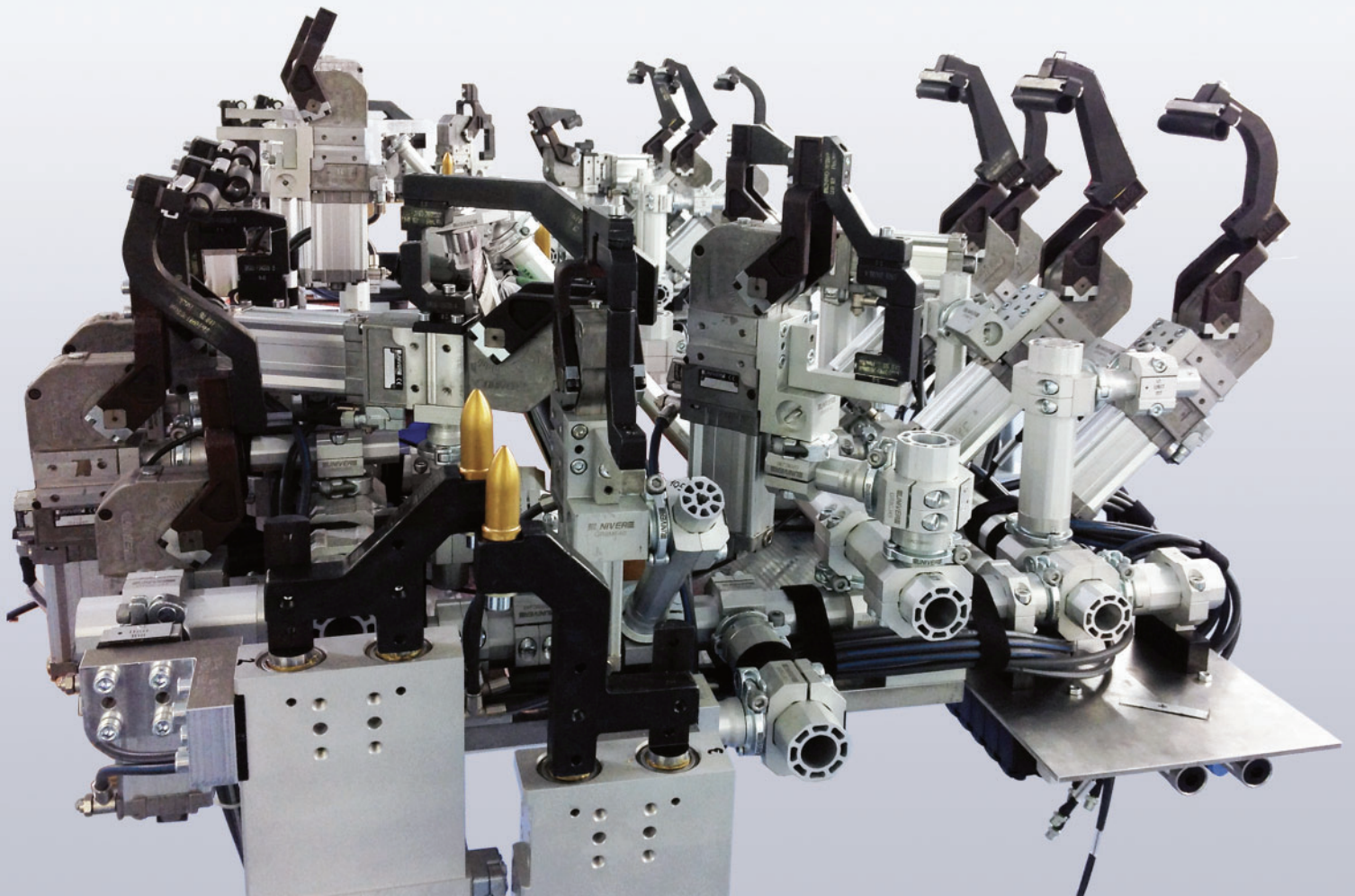



## UNIVER S.p.A.

### Headquarters

20128 **Milano**  
Via Eraclito, 31  
Tel. +39 02 25298.1  
Fax +39 02 2575254  
info@univer-group.com  
www.univer-group.com

## UNIVER SERVICE S.r.l.

### Headquarters

20128 **Milano**  
Via Empedocle, 20  
Tel. +39 02 25298.1  
Fax +39 02 25298370  
universervice@universervice.it  
www.universervice.it

### Branch Offices

#### LOMBARDIA

20099 - Sesto San Giovanni **Milano**  
Via G. di Vittorio, 307/20  
Tel. +39 02 26261304  
Fax +39 02 24300375  
universervice@universervice.it

#### PIEMONTE/LIGURIA/VALLE D'AOSTA

10071 Borgaro Torinese **Torino**  
Via Veneto, 18  
Tel. +39 011 4501871  
Fax +39 011 4502898  
torino@universervice.it

#### VENETO/FRIULI VENEZIA-GIULIA TRENTINO-ALTO ADIGE

30030 Vigonovo **Venezia**  
Via Prima strada 16/A - Loc. Galta  
Tel. +39 049 9834140  
Fax +39 049 9833972  
vigonovo@universervice.it

#### EMILIA ROMAGNA

40069 Zola Predosa **Bologna**  
Via Balzani, 5  
Tel. +39 051 753907  
Fax +39 051 6184751  
bologna@universervice.it

#### CENTRO/SUD

40069 Zola Predosa **Bologna**  
Via Balzani, 5  
Tel. +39 051 753907  
Fax +39 051 6184751  
bologna@universervice.it

#### UNIVER DO BRASIL Ltda

**BRAZIL** - 13474-764  
**Americana São Paulo**  
Rua do Polyester, 29  
Distrito Industrial Abdo Najar  
Tel. +55 19 3113-9400  
Fax +55 19 3113-9405  
atendimento@univer.com.br

#### UNIVER CHINA

**CHINA** - Shanghai  
399 Fu Te North Road,  
Free Zone, Pudong  
info@univer-china.com

#### UNIVER FRANCE S.a.s.

**FRANCE** - 68000  
**Colmar**  
1, rue Denis Papin  
Tel. +33 3 89210900  
Fax +33 3 89216850  
info@univer-france.fr

#### UNIVER G.m.b.H.

**GERMANY** - D-65428  
**Rüsselsheim**  
Eisenstraße 51  
Tel. +49 6142 408320  
Fax +49 6142 4083290  
info@univer-gmbh.de

#### UNIVER NORTH AMERICA

**USA** - 48312  
Sterling Heights - **Michigan**  
6620 Cobb Drive  
Tel. +1 248 299 0525  
Fax +1 248 299 0528  
info@univer-group.us

#### UNIVER POLSKA Sp. z o.o.

**POLAND** - 25-663  
**Kielce**  
ul. K. Olszewskiego 21E  
Tel. +48 41 278 72 53  
Fax +48 41 278 72 54  
univer@univer-group.pl

#### UNIVER S.L.

**SPAIN** - 08210  
Barbera Del Valles **Barcelona**  
Ronda Industria, 26 - 28  
Tel. +34 93 7297360  
Fax +34 93 7297380  
univer@univerweb.com

#### Distributors worldwide:

Get in touch with UNIVER Sales Department  
or visit our website [www.univer-group.com](http://www.univer-group.com)



[www.univer-group.com](http://www.univer-group.com)